

Plena Loop Amplifier



Security Systems

en | Installation and User Instructions
PLN-1LA10

BOSCH

Important safeguards

Before you install or operate the Plena Loop Amplifier, you must read the Important Safety Instructions. The Important Safety Instructions are supplied together with the Plena Loop Amplifier.

Acknowledgements

Bosch Security Systems thanks the NVVS (Dutch Association of Hard of Hearing People) for the valuable information that was provided during the development of the Plena Loop Amplifier and the creation of the Installation and User Instructions.

About this manual

Function

The Installation and User Instructions gives the installers and operators the necessary data to install, configure and operate the Plena Loop Amplifier.

Digital version

The Installation and User Instructions is available as a digital file (Portable Document File, PDF).

When the PDF refers you to a location that contains more data, you can click the text to go there. The text contains hyperlinks.

Precautions and notes

The Installation and User Instructions uses precautions and notes. The precaution gives the effect if you do not obey the instructions. These are the types:

- **Note**

A note gives more data.

- **Caution**

If you do not obey the caution, you can cause damage to the equipment.

- **Warning**

If you do not obey the warning, you can cause personal injury or death.

Signs

The Installation and User Instructions shows each precaution with a sign. The sign shows the effect if you do not obey the instruction.

**Precaution**

General sign for cautions and warnings.

**Precaution**

Risk of electric shock.

The sign that is shown along with a note gives more data about the note itself.

**Note**

General sign for notes.

**Note**

Refer to another information source.

Conversion tables

Length, mass and temperature are in SI units. Refer to the data below to change SI units to imperial units.

table 1: Conversion of units of length

1 in =	25.4 mm	1 mm =	0.03937 in
1 in =	2.54 cm	1 cm =	0.3937 in
1 ft =	0.3048 m	1 m =	3.281 ft
1 mi =	1.609 km	1 km =	0.622 mi

table 2: Conversion of units of mass

1 lb =	0.4536 kg	1 kg =	2.2046 lb
--------	-----------	--------	-----------

table 3: Conversion of units of pressure

1 psi =	68.95 hPa	1 hPa =	0.0145 psi
---------	-----------	---------	------------



Note

1 hPa = 1 mbar.

table 4: Conversion of units of temperature

$$^{\circ}F = \frac{9}{5} \cdot ^{\circ}C + 32$$

$$^{\circ}C = \frac{5}{9} \cdot (^{\circ}F - 32)$$

Table of contents

Important safeguards	3
Acknowledgements	4
About this manual	5
Table of contents	7
1. System overview	9
1.1 Loop amplifier	9
1.2 Induction loop systems	9
1.2.1 Introduction	9
1.2.2 Principle	9
1.2.3 Benefits	10
1.3 Plena	10
1.4 Block diagram	10
1.5 Supervision	10
1.6 Quadrature system	10
1.7 Controls, connectors and indicators	12
1.7.1 Front view	12
1.7.2 Rear view	12
2. Design and planning	13
2.1 Introduction	13
2.2 System types	13
2.2.1 Simple system	13
2.2.2 Quadrature systems	13
2.2.3 Expanded quadrature systems	15
2.2.4 Low-spill system	15
2.3 Induction loops	16
2.3.1 Introduction	16
2.3.2 Position	16
2.3.3 Wire diameter	16
2.3.4 Magnetic field strength	16
2.3.5 Connection	16
2.3.6 Configuration	16
2.4 Potential problems	18
2.4.1 Metal loss	18
2.4.2 Overspill	18
2.4.3 Earth loops	18
3. Installation	19
4. External connections	21
4.1 Induction loops	21
4.2 Audio inputs	21
4.3 Priority input	22
4.4 Fault output	23
4.5 Line output	23
4.6 Power supply	23
4.7 Slave to Master	25
4.8 Slave to slave	25
5. Configuration	27

5.1	Master and slaves	27
5.2	Electric current	27
5.2.1	Master induction loops	27
5.2.2	Slave induction loops	28
5.2.3	Bracket	28
5.3	Metal loss compensation	28
5.4	Supervision	29
5.5	Fault contact	29
5.6	Priority input	29
5.7	AGC/Limiter	29
5.7.1	Introduction	29
5.7.2	Switch on and off	29
5.7.3	Range	30
5.8	Frequency range	30
5.9	Audio inputs	30
5.9.1	Sensitivity	30
5.9.2	Phantom power	30
5.9.3	Voice activation	31
6.	Operation	33
6.1	Switch on	33
6.2	Switch off	33
6.3	Change volume	33
6.4	Change tone	34
6.5	Condition LEDs	34

1 System overview

1.1 Loop amplifier

The PLN-1LA10 Plena Loop Amplifier has been designed as a very high-quality amplifier for medium to large size induction loop systems. Ease of installation and use have been major factors in the design, combined with optimized performance.



figure 1.1: Plena Loop Amplifier

table 1.1: Performance

Frequency response:
60 Hz to 10 kHz (+1/-3 dB, @ -10 dB @ rated output
Distortion:
< 1% @ rated output, 1 kHz
Bass control:
-8/+8 dB @ 100 Hz
Treble control:
-8/+8 dB @ 10 kHz

table 1.2: Certifications and approvals

EMC emission:
acc. to EN55103-1
EMC immunity:
acc. to EN55103-2
Safety:
acc. to EN60065
Induction loop systems:
acc. to EN60118-4
acc. to IEC118-4

1.2 Induction loop systems

1.2.1 Introduction

An induction loop system consists of a looped wire that is installed along the walls of a room and a loop amplifier.

1.2.2 Principle

The loop amplifier changes incoming audio signals in an alternating electric current that is sent through the induction loop. The strength and frequency of the electric current varies with the tone and the amplitude of the incoming audio signal and generates an alternating magnetic field inside the induction loop. People with assistive listening devices who are located inside the induction loop, can put their assistive listening devices in the T or MT mode to listen to the audio signals.

In the T or MT mode, a little coil is activated (T stands for ‘tele-coil’). The coil receives the alternating magnetic field and changes it into an alternating voltage, which the assistive listening devices change into an audio signal. This audio signal is not entirely the same as the incoming audio signal of the loop amplifier, because the assistive listening devices also compensate for individual hearing disabilities (for example, signal strength and frequency range).

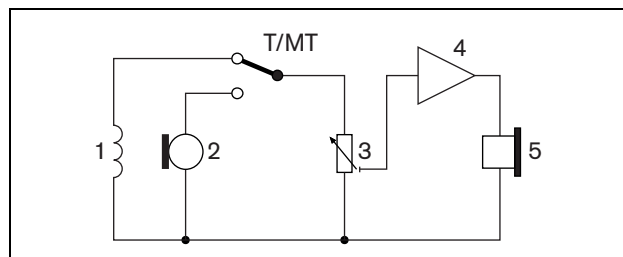

figure 1.2: Assistive listening device

table 1.3: Assistive listening device

No.	Description
1	Tele-coil
2	Microphone
3	Gain control
4	Amplifier
5	Earphone

1.2.3 Benefits

Ambient noise prevents hard-of-hearing people from listening to a specific sound in a room. The ambient noise can result from other people in the room, equipment, but also from the acoustics. Depending on the acoustics of the room, hard-of-hearing people already find the reflected noise a strain when the distance between them and the speaker is more than 2 m. The induction loop, to which the hard-of-hearing people can listen with their assistive listening devices, virtually reduces the distance to the speaker. Their distance to the speaker seems equal to the distance between the speaker and the microphone.

1.3 Plena

The Plena Loop Amplifier is part of the Plena product range. Plena provides public address solutions for places where people gather to work, worship, trade or simply enjoy themselves. It is a family of system elements that are combined to create public address systems tailored for virtually any application. The range includes mixer, pre, system and power amplifiers, a source unit, digital message manager, feedback suppressor, conventional and PC call stations, an 'All-in-One' system and a voice alarm system. Each element is designed to complement all others thanks to matched acoustical, electrical and mechanical specifications.

1.4 Block diagram

Refer to figure 1.4 for a block diagram of the Plena Loop Amplifier.

1.5 Supervision

All vital functions of the loop amplifier are supervised. The loop amplifier checks its internal power amplifier, the integrity of the connected induction loop and the priority input with a pilot tone. When a supervised function fails, a LED on the front panel of the loop amplifier is lit and the fault contact is de-energized.

1.6 Quadrature system

One of the key features of the Plena Loop Amplifier is that it can be used in quadrature systems. In a quadrature system, an even number of Plena Loop Amplifiers work together to create a magnetic field that has the same strength throughout the whole covered area and drops rapidly to zero beyond the borders of the covered area. This is achieved by introducing a phase difference of 90° in the electric current that flows through two adjacent induction loops.

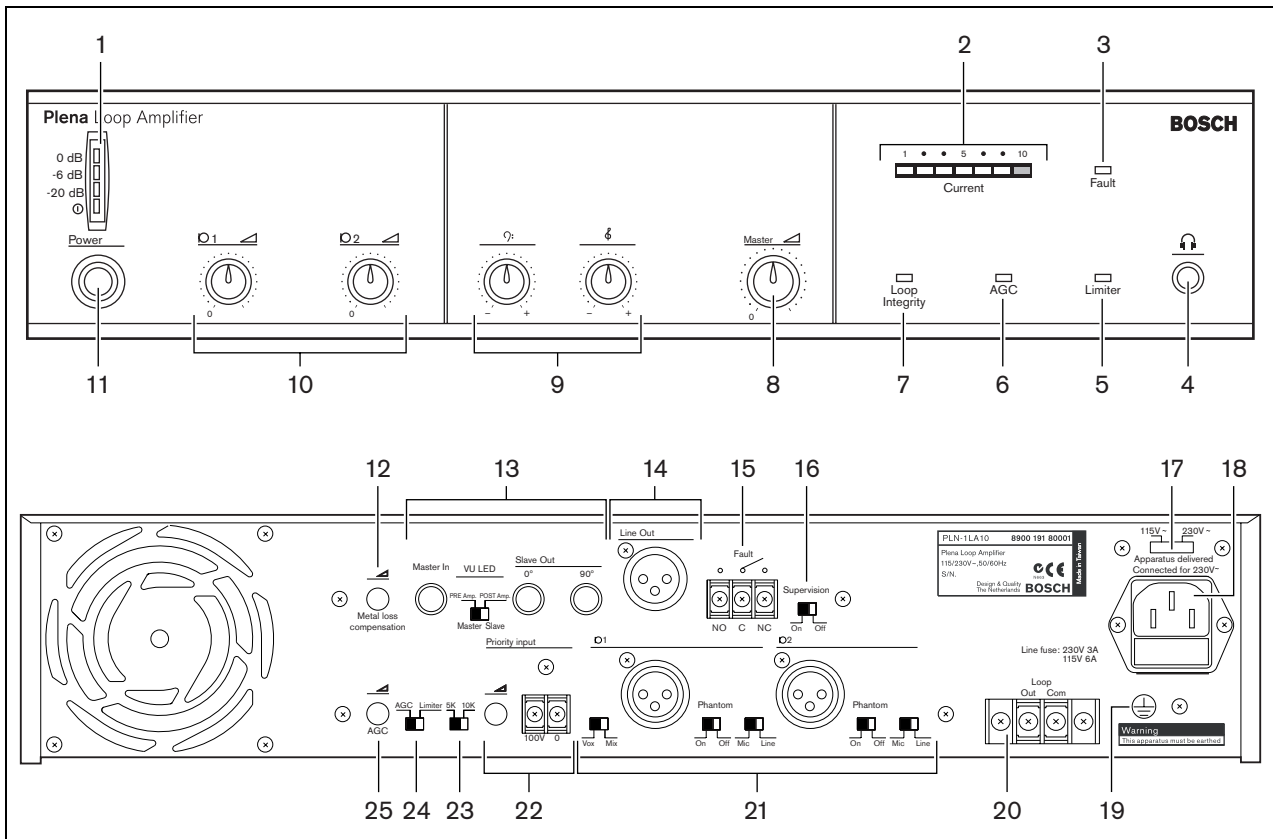

figure 1.3: Front and rear views

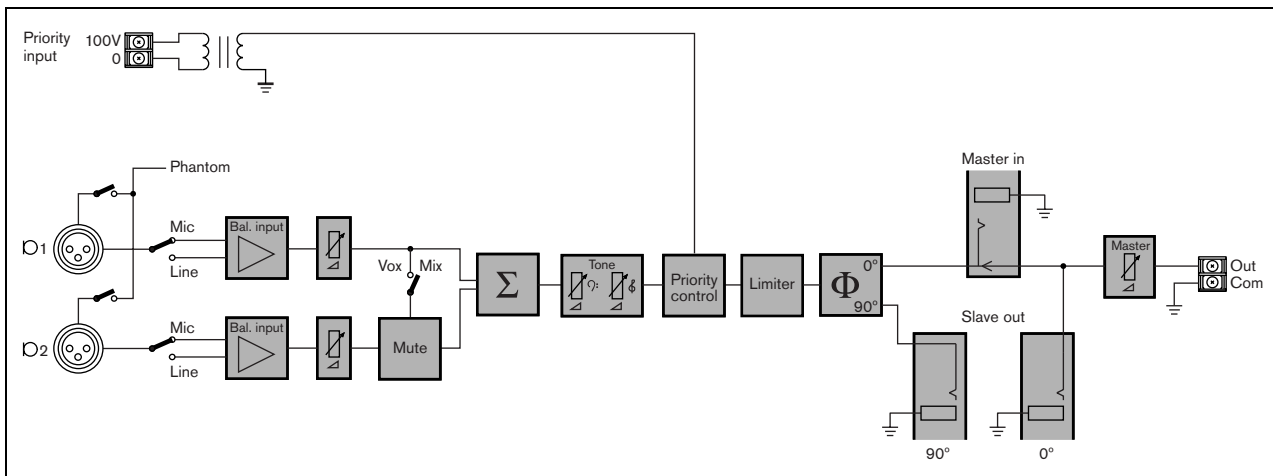

figure 1.4: Block diagram

1.7 Controls, connectors and indicators

1.7.1 Front view

The front of the loop amplifier (refer to figure 1.3) contains:

- 1 **Power LED/VU Meter** - A combined power LED and VU meter. The green power LED comes on when the loop amplifier is switched on. The VU meter shows the master VU level: 0 dB (red), -6 dB, -20 dB (yellow).
- 2 **Electric current meter** - Show the electric current through the induction loop.
- 3 **Fault LED** - Comes on when a supervised function of the loop amplifier fails (refer to section 6.5).
- 4 **Headphones socket** - Connects headphones to the loop amplifier.
- 5 **Limiter LED** - Comes on when the limiter is active (refer to section 6.5).
- 6 **AGC LED** - Comes on when the automatic gain control (AGC) is active (refer to section 6.5).
- 7 **Loop integrity LED** - Comes on when the induction loop is intact (refer to section 6.5).
- 8 **Master volume control** - Sets the maximum electric current that flows through the induction loop (refer to section 5.2).
- 9 **Tone controls** - Controls the high and low tones of the audio signal on the induction loop (refer to section 6.4).
- 10 **Input volume controls** - Control the volume of audio input 1 and audio input 2 (refer to section 6.3).
- 11 **On/off switch** - Switches the loop amplifier on and off (refer to section 6.1 and section 6.2).

1.7.2 Rear view

The rear of the loop amplifier (refer to figure 1.3) contains:

- 12 **Metal loss compensation control** - Controls the metal loss compensation (refer to section 5.3).
- 13 **Master/slave sockets** - Connect master and slaves to the loop amplifier (refer to section 4.7).
- 14 **Line output** - Connects an external recording device to the loop amplifier (refer to section 4.5).
- 15 **Fault output** - Sends the condition of the loop amplifier to other equipment (refer to section 4.4).
- 16 **Supervision switch** - Switches supervision of the priority input on and off (refer to section 5.4).
- 17 **Voltage selector** - Selects the voltage on which the loop amplifier must operate (refer to section 4.6).
- 18 **Power inlet** - Connects the loop amplifier to the mains power supply with a power cable (refer to section 4.6).
- 19 **Ground screw** - Connects the loop amplifier to ground.
- 20 **Induction loop output** - Connects the induction loop to the loop amplifier (refer to section 4.1).
- 21 **Audio inputs** - Connects the loop amplifier to external audio inputs (refer to section 4.2).
- 22 **Priority input** - Connect the loop amplifier to systems that can override the audio signal on the induction loop (refer to section 4.3). For example, a Plena Voice Alarm System or a Praesideo system.
- 23 **Frequency range switch** - Select the frequency range of the audio signal on the induction loop (refer to section 5.8).
- 24 **AGC/Limiter switch** - Selects the automatic gain control (AGC) or the limiter (refer to section 5.7.2).
- 25 **AGC range control** - Controls the range of the automatic gain control (see section 5.7.3).

2 Design and planning

2.1 Introduction

We advise you to contact the local association of hard-of-hearing people to make sure that the induction loop system will be satisfactory in every way.

2.2 System types

2.2.1 Simple system

A simple induction loop system consists of a (master) loop amplifier with one or more induction loops (refer to figure 2.1 and figure 2.2).

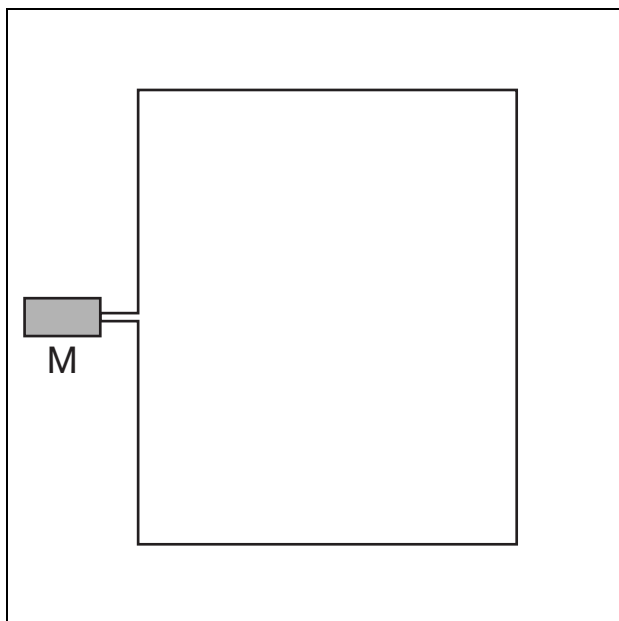

figure 2.1: Simple system, single loop

When you connect more than one induction loop to a (master) loop amplifier, make sure that the induction loops are of the same size (refer to figure 2.2).

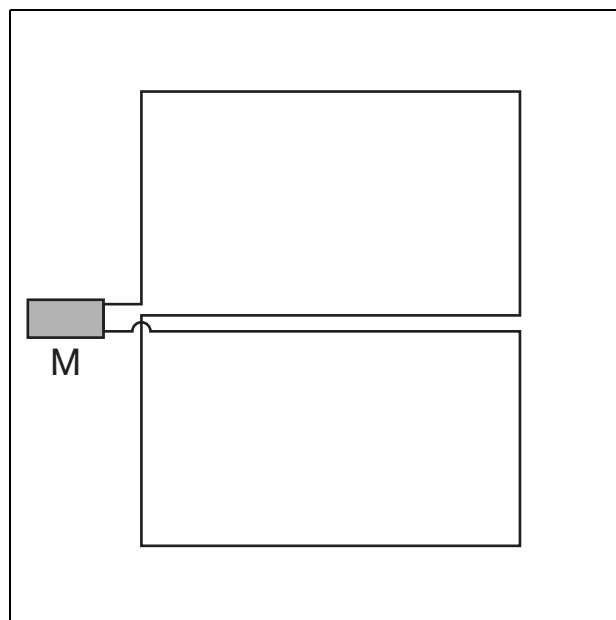

figure 2.2: Simple system, multiple loops

2.2.2 Quadrature systems

2.2.2.1 Introduction

One of the key features of the Plena Loop Amplifier is that it can be used in quadrature systems. In a quadrature system, an even number of Plena Loop Amplifiers work together to make a magnetic field that has the same strength throughout the whole covered area drops fast to zero beyond the borders of the covered area.

2.2.2.2 Simple quadrature system

A simple quadrature system consists of (refer to figure 2.3):

- A master loop amplifier (M) with one induction loop.
- A slave loop amplifier (S) with one induction loop.



Note

Although it is not required, the sizes of the master and slave induction loops are typically the same.

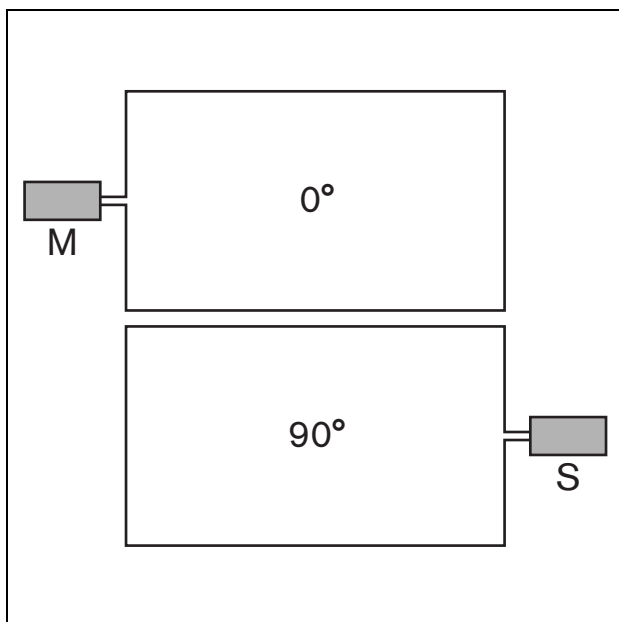

figure 2.3: Simple system, single loops

To cover larger areas, create a basic system with multiple induction loops (refer to figure 2.4 for an example). Such a system consists of:

- A master loop amplifier (M) with multiple induction loops. All master induction loops must have the same size.
- A slave loop amplifier (S) with multiple induction loops. All slave induction loops must have the same size.



Note

Although it is not required, the sizes of the master and slave induction loops are typically the same.

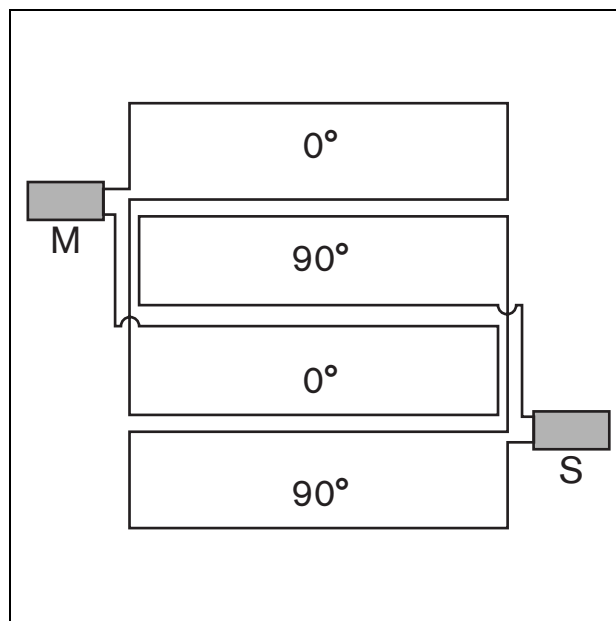

figure 2.4: Simple system, multiple loops

2.2.3 Expanded quadrature systems

To cover very large areas, create an expanded quadrature system (refer to figure 2.5 for an example).

Such a system consists of:

- A master loop amplifier (M) with one or more induction loops. All master induction loops must have the same size.
- An odd number of slave amplifiers (S1, S2, S3, etc.) with one or more induction loops. All slave induction loops must have the same size.



Note

Although it is not required, the sizes of the master and slave induction loops are typically the same.

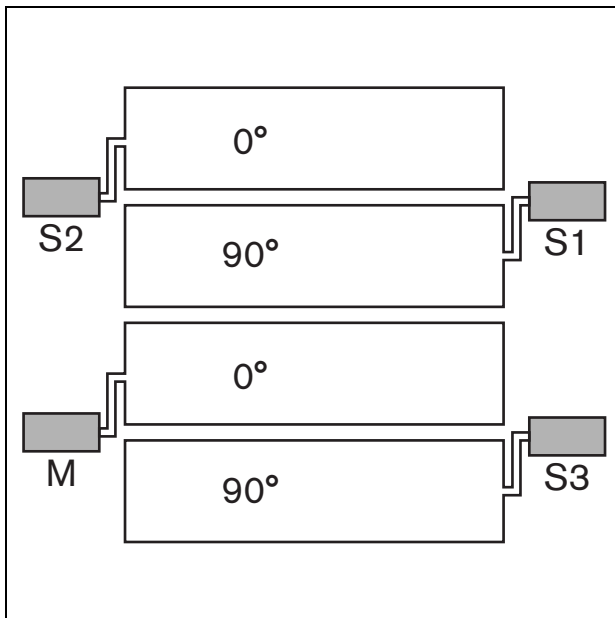

figure 2.5: Expanded system (example)

2.2.4 Low-spill system

A special type of quadrature system is the low-spill system (refer to figure 2.6 for an example). A low-spill system makes sure that the magnetic field strength drops even more rapid to zero beyond the borders of the covered area. Such a system consists of:

- A master loop amplifier (M) with one or more induction loops. All master induction loops must have the same size.
- An odd number of slave amplifiers (S1 in this example) with one or more induction loops. All slave induction loops must have the same size.
- Two slave amplifier (S2 and S3 in this example) with one induction loop. The width of the induction loops must be between 50 and 66% of the width of the master induction loops.

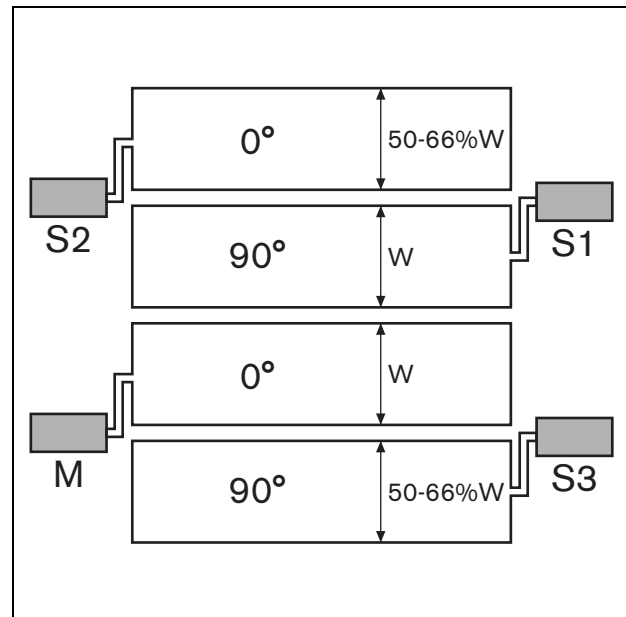

figure 2.6: Low-spill system (example)

2.3 Induction loops

2.3.1 Introduction

When you make an induction loop, you must take a number of parameters into consideration. However, sometimes there are special situations, which make the design and planning of the induction loop even more important. A number of potential problems and solutions will be discussed later.

2.3.2 Position

For the best audio quality and the smallest variation in the magnetic field strength, the distance between the induction loop and the listening plane must be between 12 and 15% of the width of the room (refer to figure 2.7).

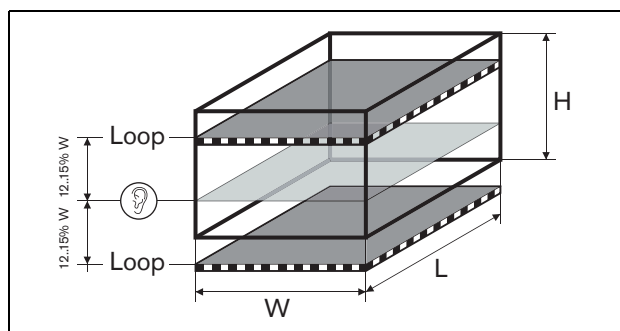

figure 2.7: Position

For example, in a room with a width (W) of 10 m, the induction loop should be installed 0 to 0.4 m below or 2.4 to 2.8 m above the floor for the best audio quality and the smallest variation in the magnetic field strength.

Typically, you will install the induction loop in the floor or in the ceiling of a room. When the distance between the floor and the induction loop is too small (less than 8% of the width) or too large (more than 20% of the width), refer to figure 2.8. The figure 2.8 shows the extra power that the loop amplifier needs to make the correct magnetic field. The numbers next to the curves show the distance from the floor to the induction loop in % of the width (W) of the room.

2.3.3 Wire diameter

For the best audio quality, the DC (direct current) resistance of the induction loop must be between 1 and 3 Ω . The DC resistance depends on the wire diameter and the wire length. Do as follows:

- 1 Calculate the wire length. The wire length depends on the size of the induction loop.
- 2 Use figure 2.9 to get the allowed wire diameter.

For example, in a rectangular room with a width (W) of 10 m and a length (L) of 30 m, the wire length is 80 m. According to figure 2.9, the wire diameter must be between 0.77 and 1.34 mm. Thus, you can use AWG 20 wire or a wire with a standard diameter of 1.00 mm.

2.3.4 Magnetic field strength

For the best audio quality, the vertical component of the magnetic field must be 100 mA/m \pm 3 dB at 1.2 m above the floor in the area that is surrounded by an induction loop. The strength of the magnetic field depends on the electric current through the induction loop. Peaks in the strength of the magnetic field must be less than 400 mA/m at 1.2 m above the floor in the area that is surrounded by the induction loop.

2.3.5 Connection

Refer to section 4.1 for instructions that tell you how to connect an induction loop to the loop amplifier.

2.3.6 Configuration

Refer to section 5.2 for instructions that tell you how to configure the electric current through the induction loop.

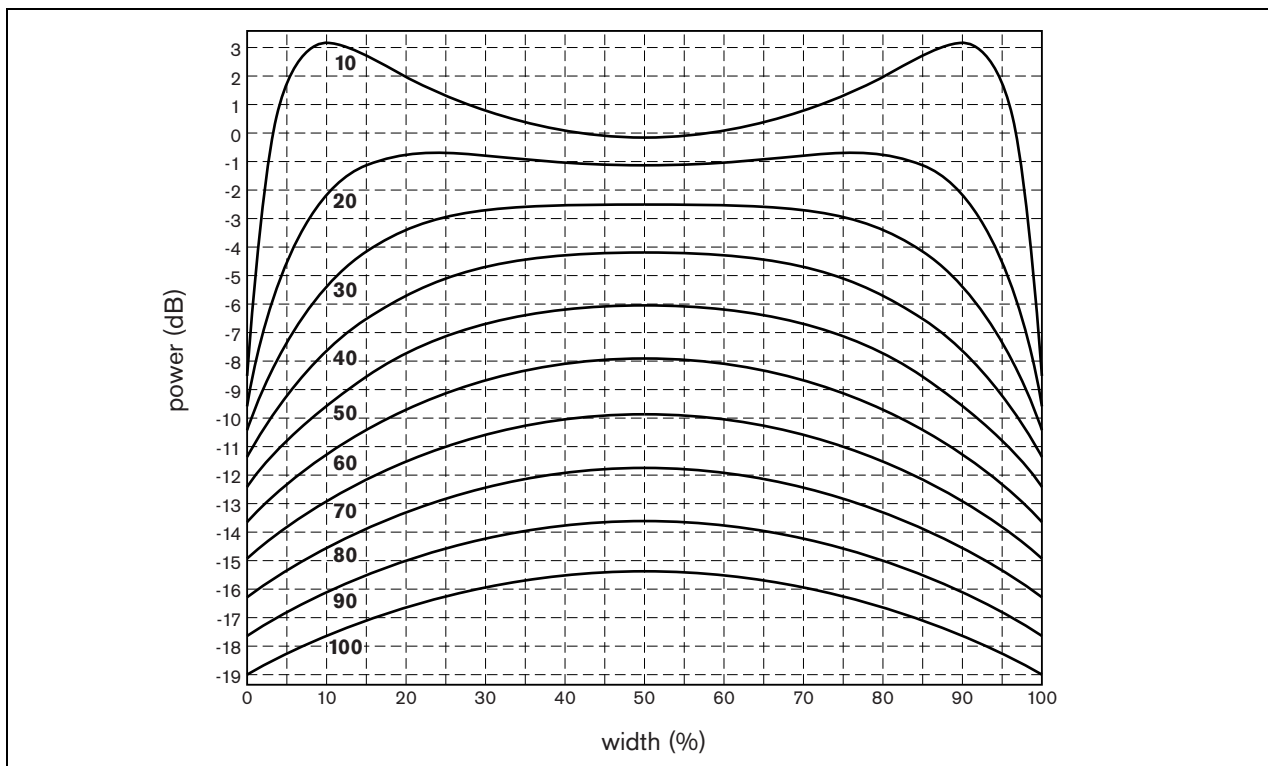

figure 2.8: Extra power vs. the width of the room

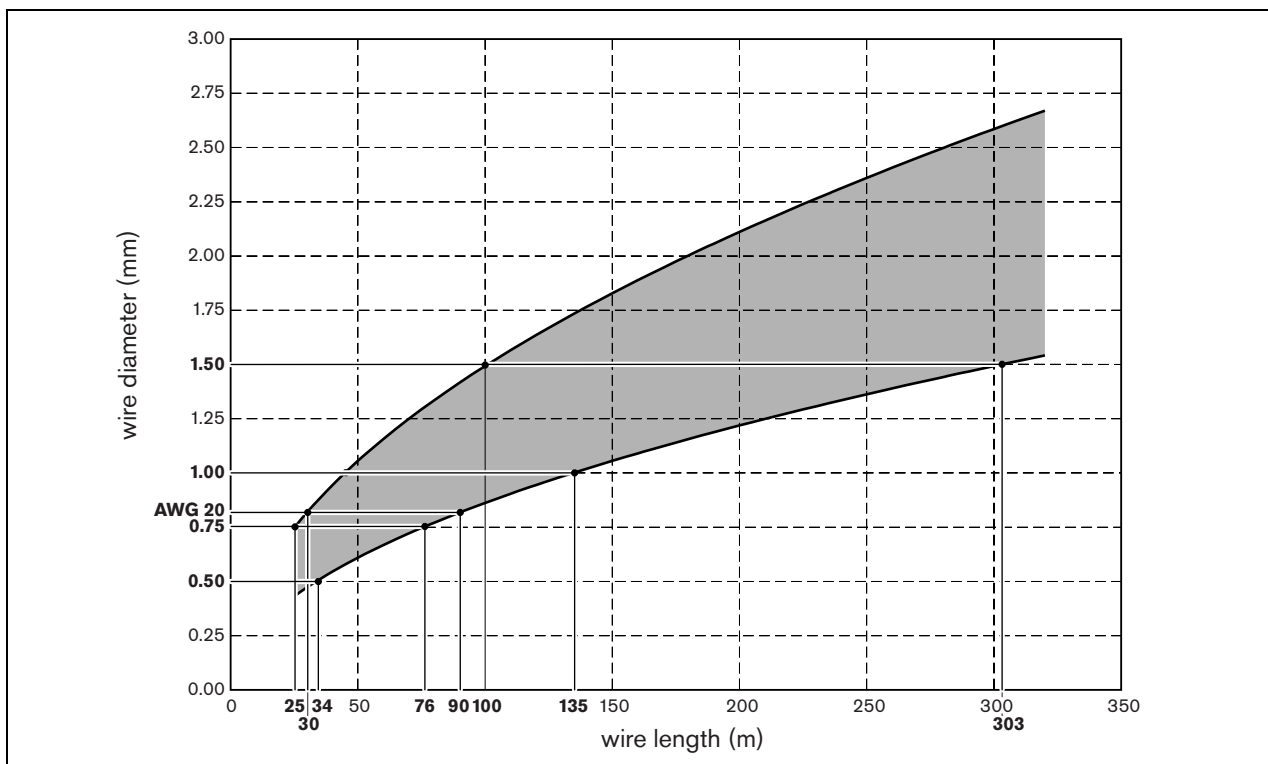

figure 2.9: Wire diameter vs. the wire length (copper wires)

2.4 Potential problems

2.4.1 Metal loss

New buildings often contain a large amount of metal (for example, meshes in concrete floors and ceilings). The metal will have an effect on the high frequencies of the signal. You can adjust the tone of the audio signal on the induction loops with the Metal loss compensation control on the rear of the loop amplifier (refer to section 5.3). The metal loss compensation is a variable, signal dependent addition of high frequencies.

2.4.2 Overspill

The larger the induction loops, the more overspill. When there is overspill, people outside the room with the induction loop system can overhear the audio signal on the induction loop. Overspill can also cause interference on other induction loop systems in the same building.

When you design a quadrature system (refer to section 2.2.2 and section 2.2.3) or a low-spill system (refer to section 2.2.4), you can avoid large induction loops and thus avoid the potential problem of overspill.

2.4.3 Earth loops

Earth loops can cause interference on the induction loop system. You can avoid earth loops when you connect the shielding of cables only to one device.

3 Installation

The loop amplifier is sent to you in a box. Refer to table 3.1 for the contents of the box.



Note

Always compare the contents of a shipment with the descriptions on the shipment documents.

table 3.1: Box

Description	Quantity
Loop amplifier	1 x
Important Safety Instructions	1 x
Installation & User Instructions	1 x
Power cable	1 x
19" rack system brackets	2 x
Cover bracket	1 x
XLR cable	1 x



Caution

Do not unpack the box until you install and connect the loop amplifier.

Install the loop amplifier in a 19-inch rack system or on a flat surface (refer to figure 3.1).

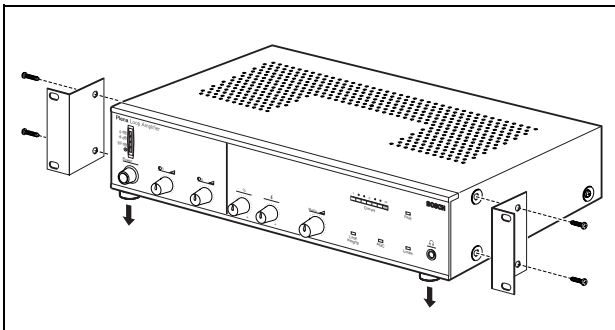

figure 3.1: Installation

Make sure that there is a free space of at least 100 mm on both sides of the loop amplifier for ventilation. The loop amplifier has a regulated internal fan, which keeps the temperature of the electronics within the safe range.

table 3.2: Physical characteristics

Dimensions (h x w x d):

94 x 430 x 320 mm (19" wide, 2U high)

Weight:

11.6 kg

table 3.3: Environmental conditions

Operating temperature:

+5 to +45 °C

Storage temperature:

-25 to +55 °C

Relative humidity:

< 95%

Intentionally left blank.

4 External connections

4.1 Induction loops

Connect the induction loops to the rear of the loop amplifier (refer to figure 4.1). Always twist wires that run parallel and close to each other to avoid additional and undesired inductions.

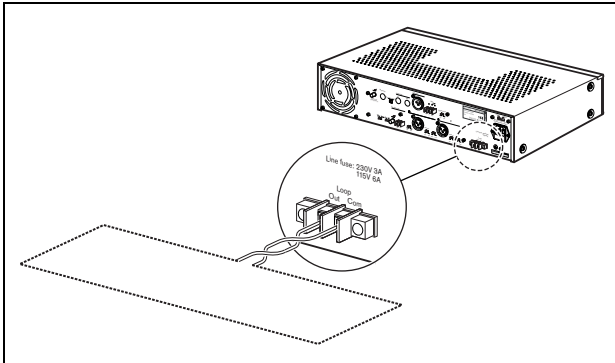

figure 4.1: Induction loop, connection

table 4.1: Induction loop, details

Number of connections:
1x screw terminal
Location:
Rear side
Current:
max. 10 A peak, max. 6 A continuous
Induction loop DC resistance:
0.5 to 3 Ω
Induction loop area:
max. 600m ² @ 100 mA _{RMS} /m

4.2 Audio inputs

You can connect audio sources to the audio inputs of the loop amplifier. For example, you can connect a power amplifier and a microphone (refer to figure 4.2).

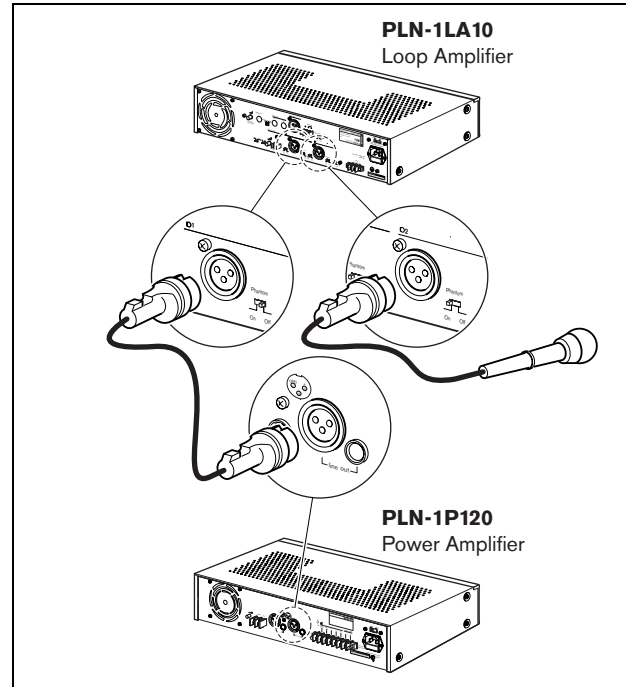

figure 4.2: Audio inputs, connection

table 4.2: Audio inputs, details

Number of connections:
2x XLR sockets
Location:
Rear side
Sensitivity:
Switchable, 1 mV/1 V
Impedance:
> 1 kΩ
Dynamic range:
100 dB
Signal-to-noise ratio:
63 dB @ max. volume
75 dB @ min. volume/mute
Headroom:
25 dB
Phantom power:
Switchable, 16 V
VOX functionality:
Switchable, input 1 mutes input 2

4.3 Priority input

You can connect other devices or systems to the priority input. The priority input has a higher priority than audio input 1 and audio input 2. When the priority input receives a signal, the loop amplifier replaces the signal on the connected induction loops with the signal of the priority input.

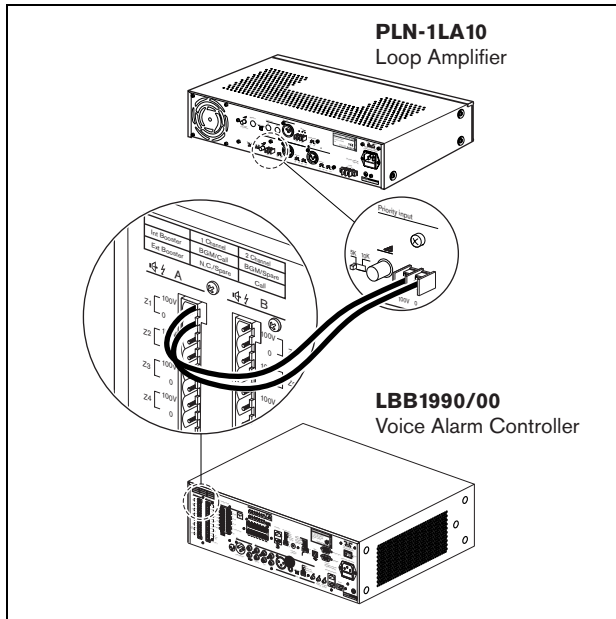

figure 4.3: Priority input, connection

For example, you can connect a Plena Voice Alarm System (refer to figure 4.3) to the priority input.



Caution

Install the safety bracket on the priority input to make sure that it is not possible to touch the priority input (refer to figure 4.4).

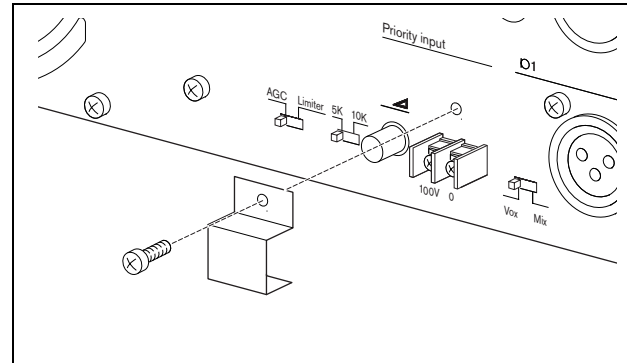

figure 4.4: Safety bracket

table 4.3: Priority input, details

Number of connections:
1x screw terminal
Location:
Rear side
Input sensitivity:
100 V, transformer-balanced
Signal-to-noise ratio:
63 dB @ max. volume
75 dB @ min. volume/mute
Headroom:
25 dB

4.4 Fault output

With the fault output (refer to figure 4.5), you can send the condition of the loop amplifier to external devices (for example, sounders).

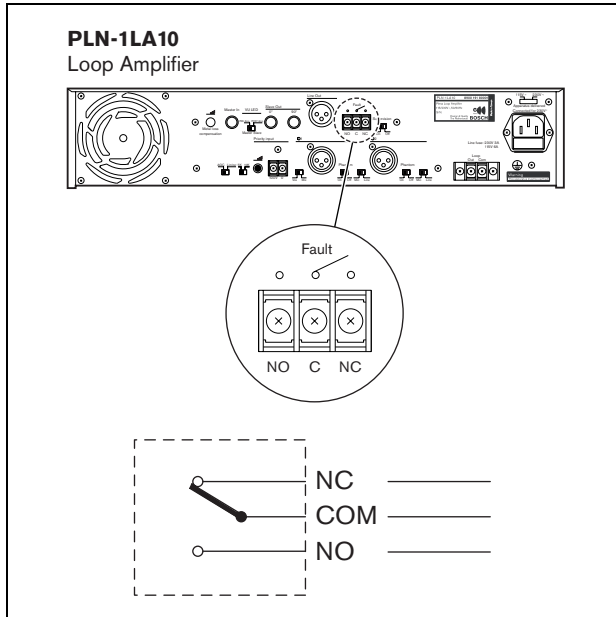

figure 4.5: Fault output, relay

The fault output is an internal relay. By default, NC is connected to COM. When a supervised function of the loop amplifier fails, the relay connects NO to COM.

table 4.4: Fault output, details

Number of connections:
1x screw terminal
Location:
Rear side
Contacts:
Voltage-free, max. 100 V, 2 A
Signal-to-noise ratio:
63 dB @ max. volume
75 dB @ min. volume/mute
Headroom:
25 dB

4.5 Line output

You can connect a recording device (for example, a tape deck) to the line output of the loop amplifier (refer to figure 4.6).

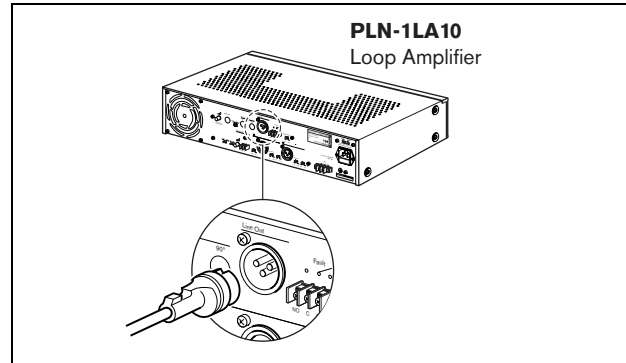

figure 4.6: Line output, connection

table 4.5: Line output, details

Number of connections:
1x XLR plug
Location:
Rear side
Nominal level:
1 V
Impedance:
200 Ω

4.6 Power supply

To connect the loop amplifier to a mains power supply do as follows:

- 1 Set the voltage selector on the rear of the loop amplifier to the correct position (refer to table 4.6).

table 4.6: Voltage selector

Power supply voltage	Voltage selector
100 to 120 V(AC)	115
220 to 240 V(AC)	230



Note

The PLN-1LA10 Loop Amplifier is delivered with the voltage selector in the 230 position.

- 2 Make sure that the fuse holder in the rear of the loop amplifier contains the correct fuse (refer to table 4.7).

table 4.7: Fuses

Voltage selector	Fuse
115	10AT
230	6.3AT



Note

The PLN-1LA10 Loop Amplifier is delivered with a 6.3AT fuse.

- 3 Connect a locally approved power cable from the loop amplifier to a power outlet (refer to figure 4.7).

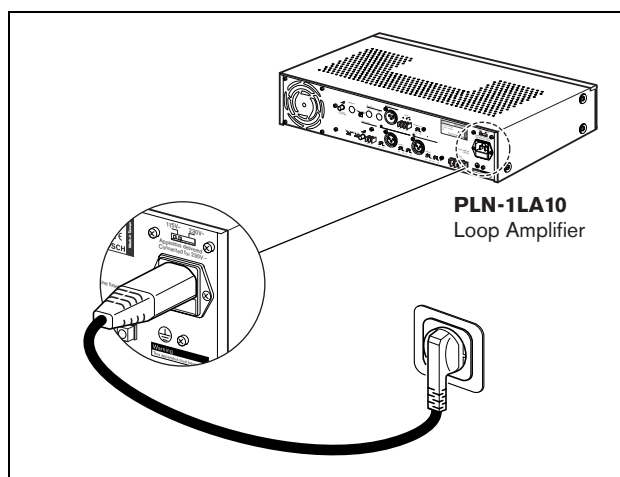

figure 4.7: Power supply, connection

table 4.8: Power supply, details

Mains voltage:
230/115 V(AC), $\pm 10\%$, 50/60 Hz
Power consumption:
max. 400 W
Mains inrush current:
max. 7 A @ 230 V(AC), max. 14 A @ 115 V(AC)
Signal-to-noise ratio:
63 dB @ max. volume
75 dB @ min. volume/mute
Headroom:
25 dB

4.7 Slave to Master

Connect the 0° Slave Out socket of the master loop amplifier to the Master in socket of the slave loop amplifier. For an example, refer to the connection from Master to Slave 2 in figure 4.8 and the connection from Master to Slave 1 in figure 4.8.

4.8 Slave to slave

Connect the 0° Slave Out socket of the slave loop amplifier to the Master in socket of the next slave loop amplifier. For an example, refer to the connections from Slave 1 to Slave 3 and Slave 2 to Slave 4 in figure 4.8.

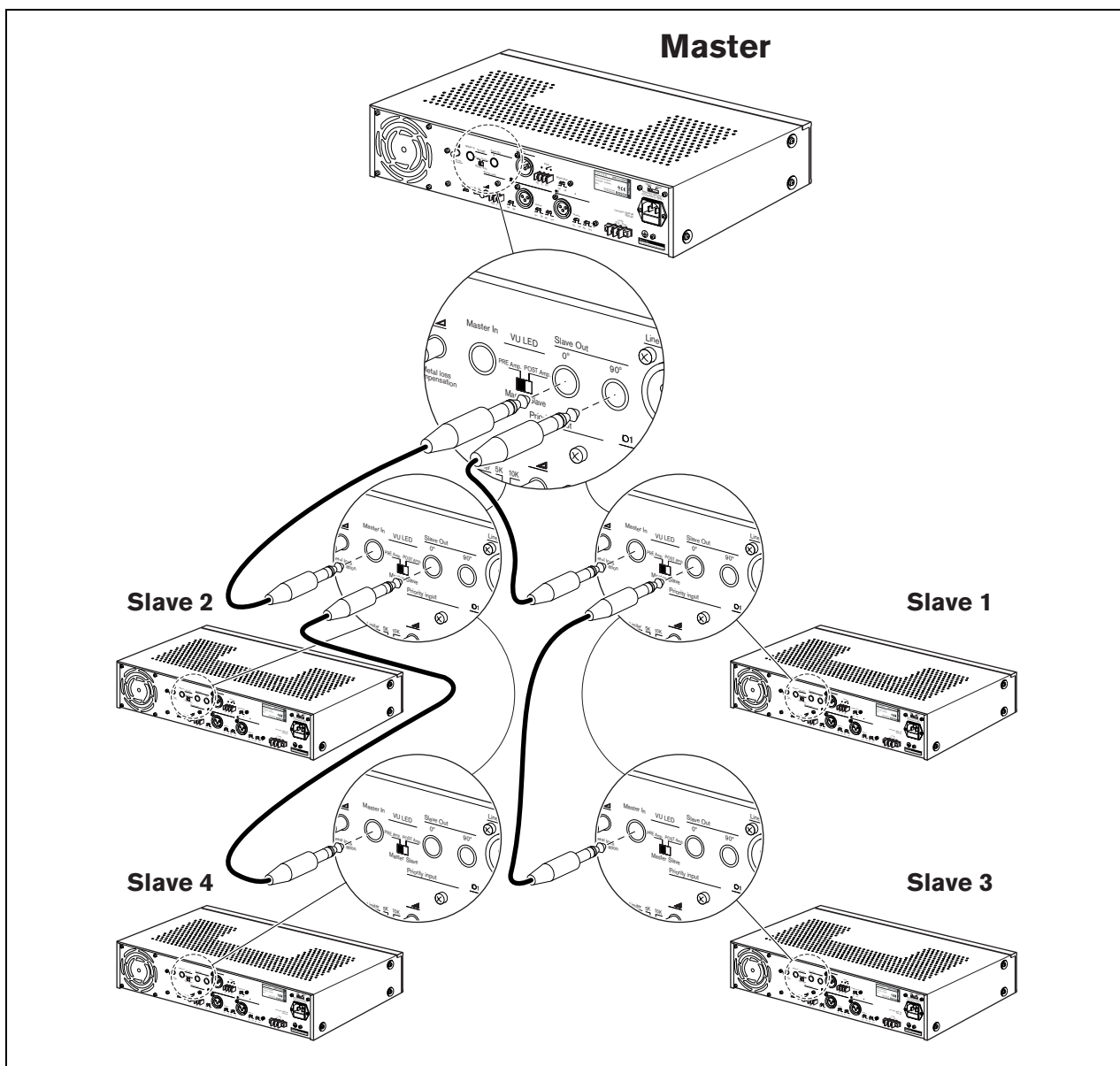

figure 4.8: Master and slave loop amplifiers

Intentionally left blank.

5 Configuration

5.1 Master and slaves

Set the Master in/Slave out switches on the rear of all loop amplifiers (refer to figure 5.1) in the induction loop system in the correct position.

- The Master/Slave switch of the master loop amplifier must be in the Master position.
- The Master/Slave switch of all slave loop amplifiers must be in the Slave position.

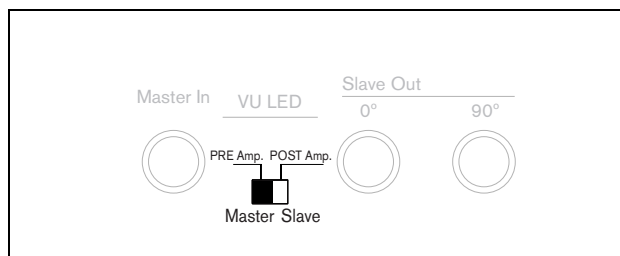

figure 5.1: Master/Slave switch



Note

Slave loop amplifier can only send the signal that they receive from the master loop amplifier to their induction loops. The audio inputs and the priority input of the slave loop amplifiers are disabled.

5.2 Electric current

5.2.1 Master induction loops

Do as follows:

- 1 Connect a pink noise source to audio input 2 on the rear of the master loop amplifier.
- 2 Connect the master loop amplifier to the mains power supply with a power cable.
- 3 Set the AGC/Limiter switch on the rear of the master loop amplifier in the Limiter position.
- 4 Switch on the pink noise source.
- 5 Set the signal strength of the output signal of the pink noise source to 0 dBV.
- 6 Switch on the master loop amplifier with the power switch on the front.
- 7 Increase the volume of audio input 2 of the master loop amplifier with its input volume control until the Limiter LED on the front of the master loop amplifier comes on.
- 8 Increase the electric current through the master induction loops with the Master volume control on the front of the master loop amplifier until the magnetic field strength in each master induction loop is 100 mA/m.



Note

Instead of a pink noise source, you can use a sine wave of 1 kHz. Then, the magnetic field strength must be 70 mA/m in each master induction loop.

- 9 Switch off the master loop amplifier with the power switch on the front.
- 10 When the induction loop system contains slave loop amplifiers, configure the electric current through the slave induction loops (refer to section 5.2.2).

5.2.2 Slave induction loops

Do as follows:

- 11 Disconnect the master induction loops from the master loop amplifier.
- 12 Connect the slave loop amplifier to the mains power supply with a power cable.
- 13 Set the AGC/Limiter switch on the rear of the slave loop amplifier in the Limiter position.
- 14 Switch on the master loop amplifier with the power switch on the front of the master loop amplifier.
- 15 Switch on the slave loop amplifier with the power switch on the front of the slave loop amplifier. When the induction loop system contains more than one slave loop amplifier, make sure that all other slave loop amplifiers are off.
- 16 Increase the volume of audio input 2 of the slave loop amplifier with its volume control until the Limiter LED on the front of the slave loop amplifier comes on.
- 17 Increase the electric current through the slave induction loops with the Master volume control on the front of the slave loop amplifier until the magnetic field strength in each slave induction loop is 100 mA/m (pink noise source) or 70 mA/m (sine wave of 1 kHz).
- 18 Switch off the slave loop amplifier with the power switch on the front of the slave loop amplifier.
- 19 Repeat the procedure for the other slave loop amplifier in the induction loop system.



Note

Do not forget to re-connect all induction loops after you have configured the electric current through the induction loop of the last loop amplifier.

5.2.3 Bracket

You can cover the front of the loop amplifier with a bracket (refer to figure 5.2). When you cover the front, you make sure that nobody can change the position of the volume controls. Thus, you make sure that nobody can change the electric current through the induction loop that is connected to the loop amplifier.

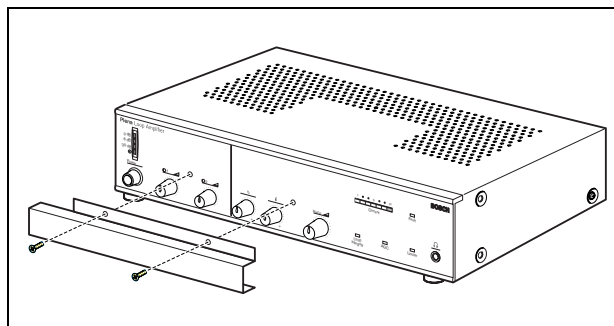

figure 5.2: Cover bracket

5.3 Metal loss compensation

Do as follows:

- 1 Turn the Metal loss compensation control on the rear of the loop amplifier to the leftmost position.
- 2 Connect headphones to the headphones socket on the front of the loop amplifier to listen to the audio signal that is sent to the connected induction loops.
- 3 With the same headphones, listen to the audio signal on the induction loops through an induction loop receiver.
- 4 Turn the Metal loss compensation control to adjust the tone of the audio signal on the induction loops.
- 5 Repeat the procedure for the other loop amplifiers in the induction loop system.

5.4 Supervision

You can switch supervision (refer to section 1.5) on and off with the Supervision switch. The Supervision switch is on the rear of the loop amplifier (refer to figure 5.3).

- To switch on supervision, set the Supervision switch in the ON position.
- To switch off supervision, set the Supervision switch in the OFF position.

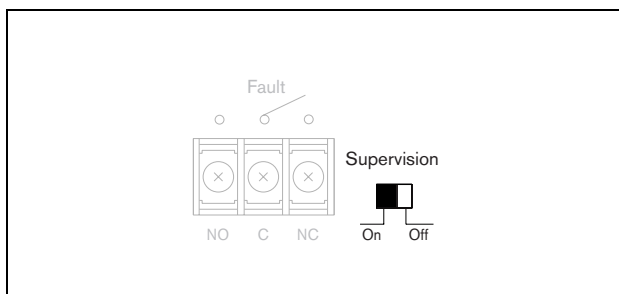

figure 5.3: Supervision switch

5.5 Fault contact

You can configure the fault contact with the Supervision switch (refer to section 5.4).

- If supervision is off, the internal relay is de-energized (NO position).
- If supervision is on and the loop amplifier operates correctly, the internal relay is energized (NC position).
- If supervision is on and the loop amplifier does not operate correctly, the internal relay is de-energized (NO position).

5.6 Priority input

You can set the volume of the audio signal that the priority input sends to the connected induction loops with the Priority input volume control. The Priority input volume control is on the rear of the loop amplifier (refer to figure 5.4).

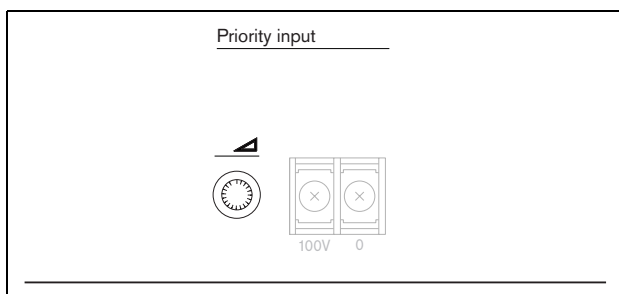

figure 5.4: Priority input volume control

5.7 AGC/Limiter

5.7.1 Introduction

Automatic gain control (AGC) keeps the level of the audio signal on the connected induction loops constant. The limiter makes sure that audio signals with a strength of more than 0 dBV are not sent to the connected induction loops.

5.7.2 Switch on and off

You can switch automatic gain control (AGC) on and off with the AGC/Limiter switch. The AGC/Limiter switch is on the rear of the loop amplifier (refer to figure 5.5).

- To switch on AGC, set the AGC/Limiter switch in the AGC position. When AGC is on, the limiter is disabled.

i Note
Do not forget to configure the AGC range (refer to section 5.7.3).

- To switch on the limiter, set the AGC/Limiter switch in the Limiter position. When the limiter is on, AGC is disabled.

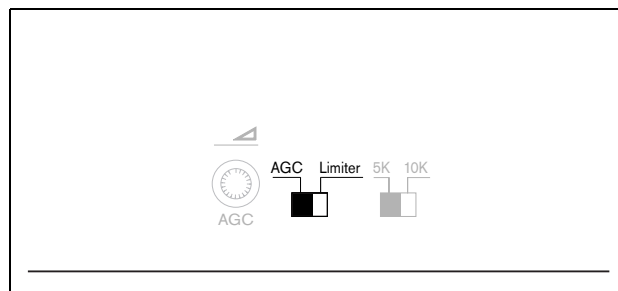

figure 5.5: AGC/Limiter switch

5.7.3 Range

You can set the AGC range with the AGC volume control. The AGC volume control is on the rear of the loop amplifier (refer to figure 5.6).

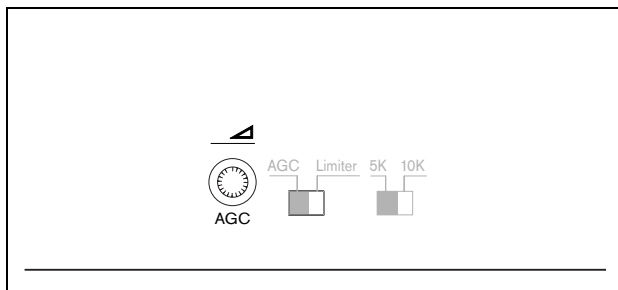

figure 5.6: AGC volume control

The correct AGC range depends on the audio input signals and the perceptions of the users of the connected induction loops. If you set the AGC range too wide, soft sounds (for example, undesired ambient noise) is amplified. If you set the AGC range too narrow, desired soft sounds are lost.

5.8 Frequency range

You can set the frequency range with the 5K/10K switch. The 5K/10K switch is on the rear of the loop amplifier (refer to figure 5.7).

- If the audio inputs contain speech, set the switch in the 5K position for the most optimal result.
- If the audio inputs contain background music, set the switch in the 10K position for the most optimal result.

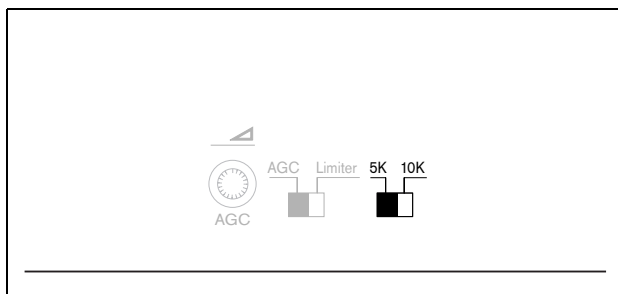

figure 5.7: Frequency range switch

5.9 Audio inputs

5.9.1 Sensitivity

You can set the sensitivity of the audio inputs with the Mic/Line switch. The Mic/Line switch is on the rear of the loop amplifier (refer to figure 5.8).

- If the connected audio source is a microphone, set the switch in the Mic position.
- If the connected audio source is a line-level source, set the switch in the Line position.

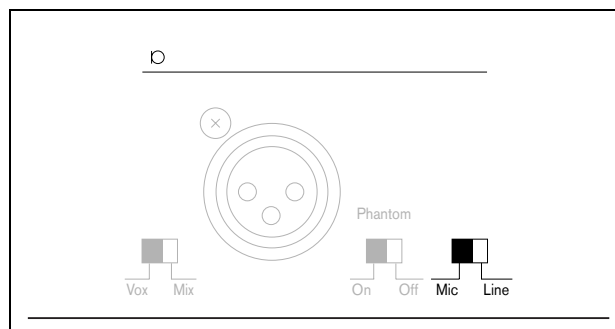

figure 5.8: Mix/Line switch

5.9.2 Phantom power

You can switch phantom power for microphones on and off with the Phantom power switch. The Phantom power switch is on the rear of the loop amplifier (refer to figure 5.9).

- If the connected audio source is a microphone that must receive phantom power, set the Phantom switch in the ON position.
- If the connected audio source is not a microphone or if the connected microphone does not accept phantom power, set the Phantom switch in the OFF position.

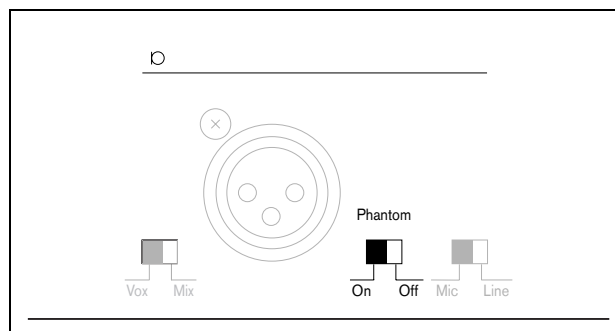

figure 5.9: Phantom switch

5.9.3 Voice activation

You can switch voice activation (Vox) of audio input 1 on and off with the Vox/Mix switch. The Vox/Mix switch is on the rear of the loop amplifier (refer to figure 5.10).

- To switch Vox on, set the Vox/Mix switch in the Vox position. The audio signal of audio input 1 overrides the audio signal of audio input 2.
- To switch Vox off, set the Vox/Mix switch in the Mix position. The audio signal of audio input 1 and the audio signal of audio input 2 are mixed.

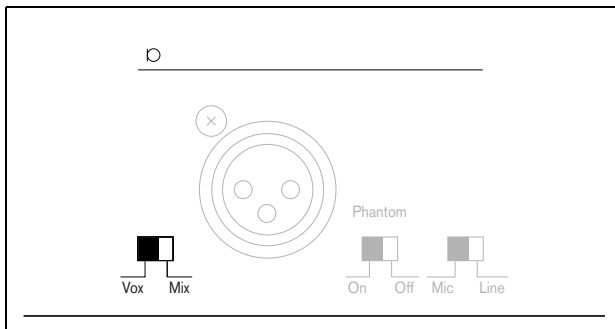

figure 5.10: Vox/Mix switch

Intentionally left blank.

6 Operation

6.1 Switch on

Push the Power switch to switch on the loop amplifier. The Power switch is on the front of the loop amplifier (refer to figure 6.1).

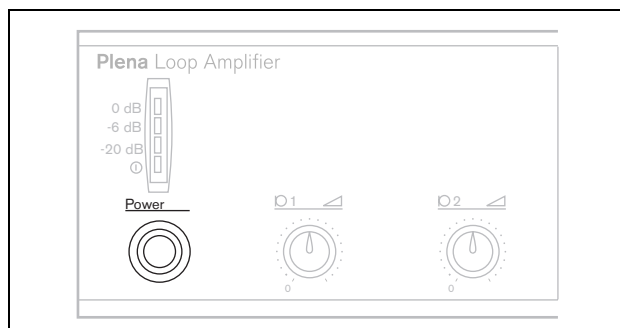

figure 6.1: Power switch

When the mains power supply is available, the green power LED on the front of the loop amplifier (refer to figure 6.2) comes on.

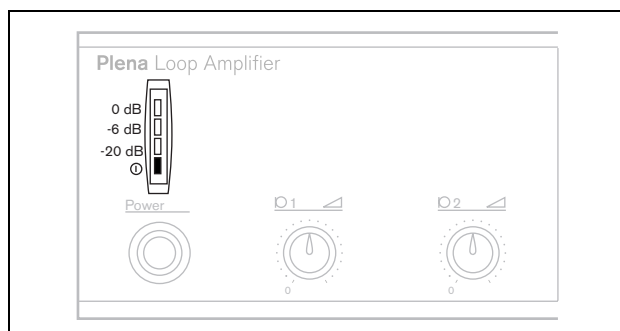

figure 6.2: Power LED

6.2 Switch off

Push the Power switch to switch off the loop amplifier. The Power switch is on the front of the loop amplifier (refer to figure 6.1). The green power LED on the front of the loop amplifier (refer to figure 6.2) goes off.

6.3 Change volume

You can change the volume of the audio signal on the connected induction loops with the input volume controls. The input volume controls are on the front of the loop amplifier (refer to figure 6.3).



Caution

Do not change the volume of the audio signal on the connected induction loops with the Master volume control. When you change the position of the Master volume control, you change the magnetic field of the connected induction loops.

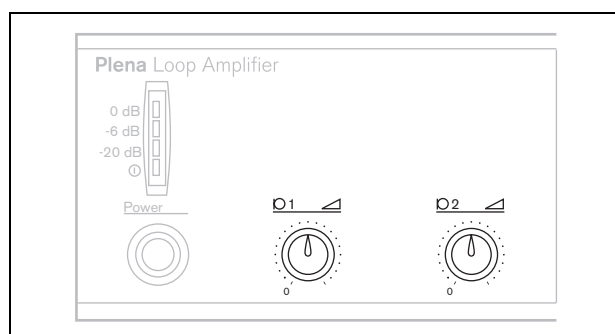

figure 6.3: Input volume controls



Note

The volume of the audio signal on the priority input is configured with a volume control on the rear of the loop amplifier (refer to section 5.6).

6.4 Change tone

You can change the tone of the audio signal on the connected induction loops with the tone controls. The tone controls are on the front of the loop amplifier (refer to figure 6.4).

- The left tone control changes the bass or low frequency content of the audio signal.
- The right tone control changes the treble or high frequency content of the audio signal.

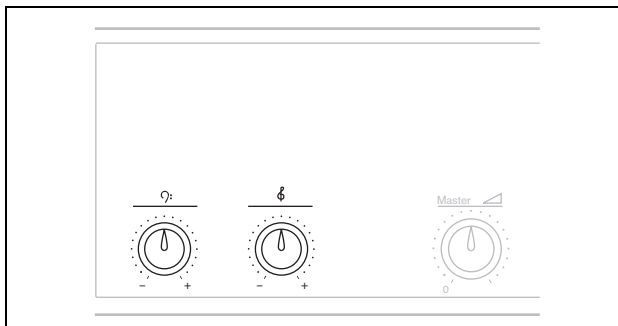

figure 6.4: Tone controls

6.5 Condition LEDs

table 6.1: Status indicators

Indicator	Description	Recommended action	Additional information
Fault	The loop amplifier does not operate correctly.	Contact your dealer when the LED goes off.	Refer to section 5.5.
Loop integrity	The induction loops are not intact.	Contact your dealer when the LED goes off.	----
AGC	The automatic gain control is on.	----	Refer to section 5.7.
Limiter	The signal of one or more of the inputs is clipped off because it is too strong.	Check which input is too loud and turn its volume control counterclockwise to decrease the volume.	Refer to section 5.7.

© Bosch Security Systems B.V.
Data subject to change without notice
2007-08 | 9922 141 50672en

BOSCH